

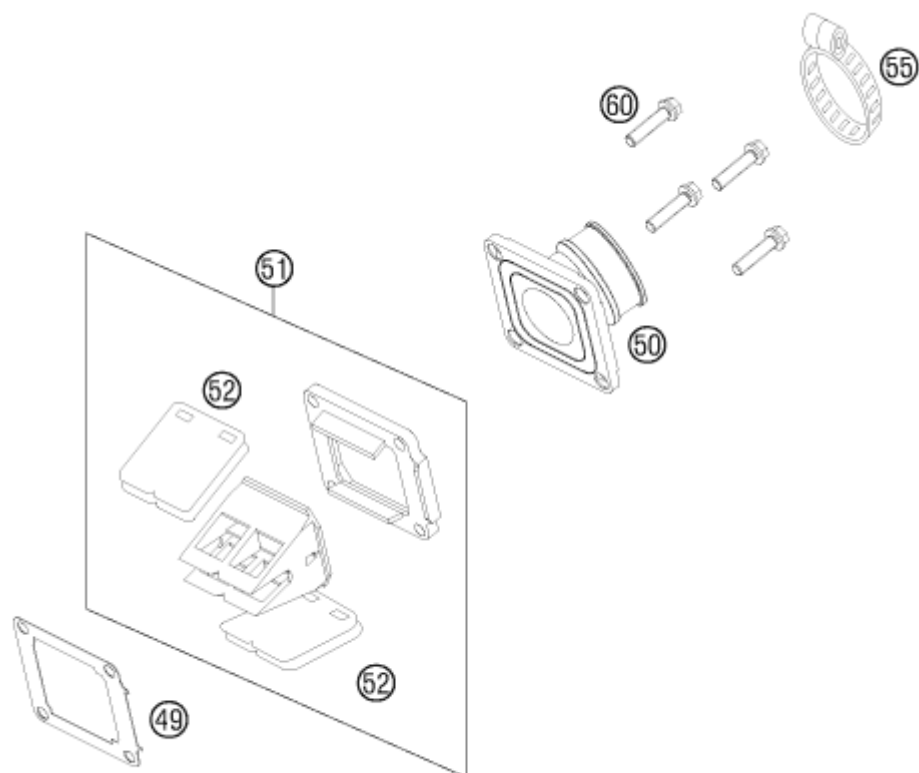

2014 / TC 85 19/16 HQV

REED VALVE HOUSING

C134703070



Position	Part number	Description	Qty
49	47030049000	GASKET FOR INTAKE FLANGE 85 SX	1
50	47030050100	INTAKE FLANGE 85 SX 2009	1
51	47030051144	REED VALVE ASSY CPL.85 SX 2009	1
52	47030052144	REED VALVE CPL. 85 SX 2009	1
55	51230061000	CLAMP 40/12 GEMI	1
60	0025060256	HH COLLAR SCREW M6X25 TX30	4