

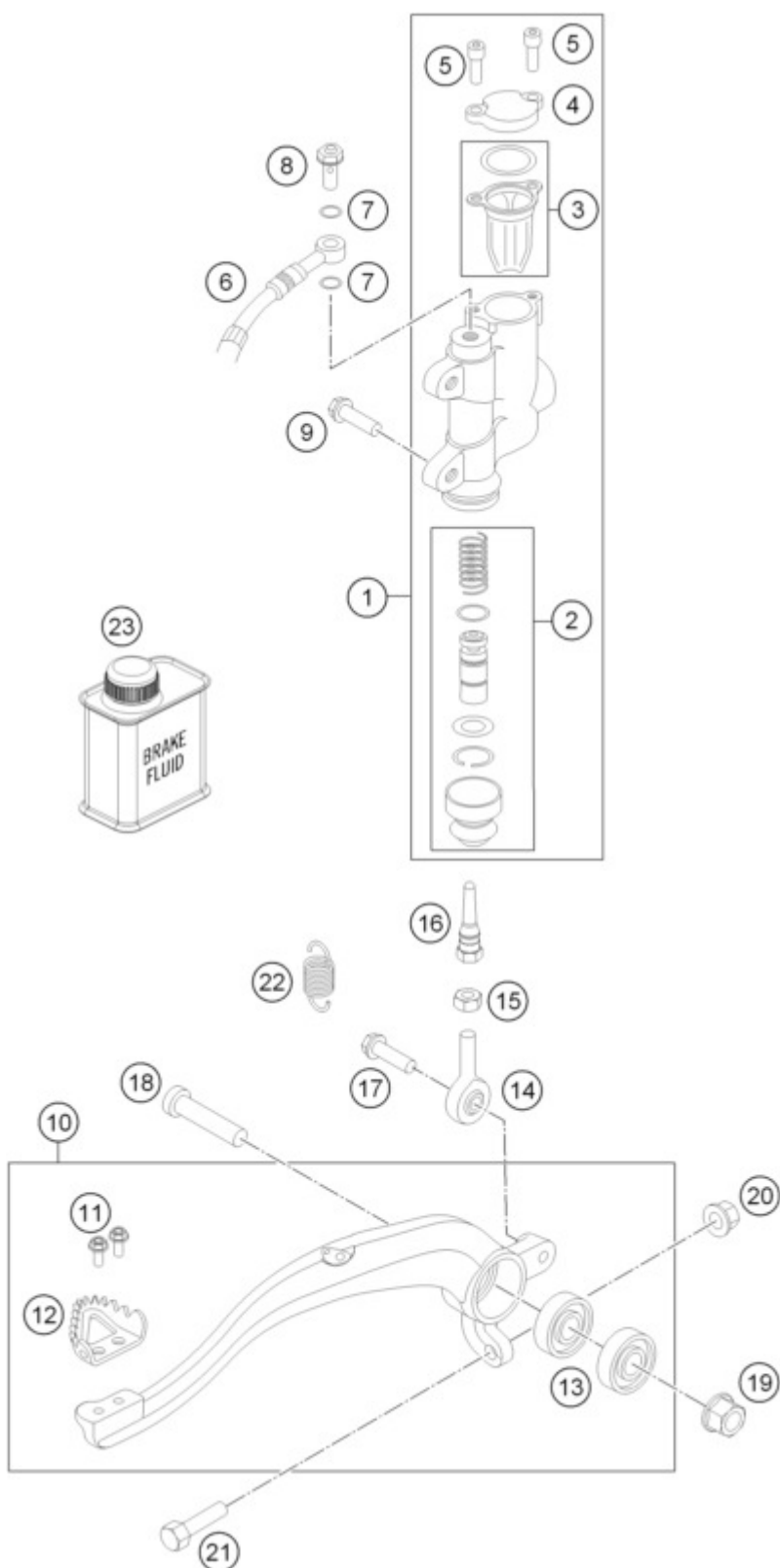

2014 / TC 85 19/16 HQV

REAR BRAKE CONTROL

C144711330



Position	Part number	Description	Qty
1	47013060300	% FOOTBRAKECYL.R. CPL. D=12 05	1
2	47013061100	REP. SET PISTON REAR D=12 2004	1
3	47013063000	GASKET CYLINDER COVER REAR 03	1
4	47013062000	CYLINDER COVER REAR 85 SX 03	1
5	0912040103	AH.SCREW DIN0912-M 4X10	2

6	47013070000	BRAKE HOSE REAR 85 SX 03	1
7	0770080019	O-RING 8,00X1,00 FORMULA	2
8	47013025000	HOLLOW SCREW BRAKE CYLINDER 03	1
9	0025060126	HH COLLAR SCREW M6X12 TX30	2
10	47013050044	FOOT BRAKE LEVER CPL. 85 SX 03	1
11	0025050126	HH COLLAR SCREW M5X12 TX30	2
12	54813051000	STEP PLATE FOR BRAKE LEVER	1
13	0625060002	BALL BEARING SKF 6000-2RS1	2
14	54813055000	SWIVEL HEAD KA6 03	1
15	0934060003	HEXAGON NUT DIN0934-M 6	1
16	47013056100	PRESSURE ROD 85 SX 06	1
17	0025060206	HH COLLAR SCREW M6X20 TX30	1
18	0032100406S	AH-COLLAR SCREW M10X40 ISA45	1
19	54630044000	COLLAR NUT M10 WS=13	1
20	46030045000	COLLAR NUT M8 WS=10	1
21	59001037000	SPECIAL SCREW M8X26 WS=10	1
22	54603062000	RETURN SPRING FOR BRAKE LEVER	1
23	00062030000	BRAKE FLUID DOT5.1 0,25L	1